

Max F = 0,4 x 45° (4x)

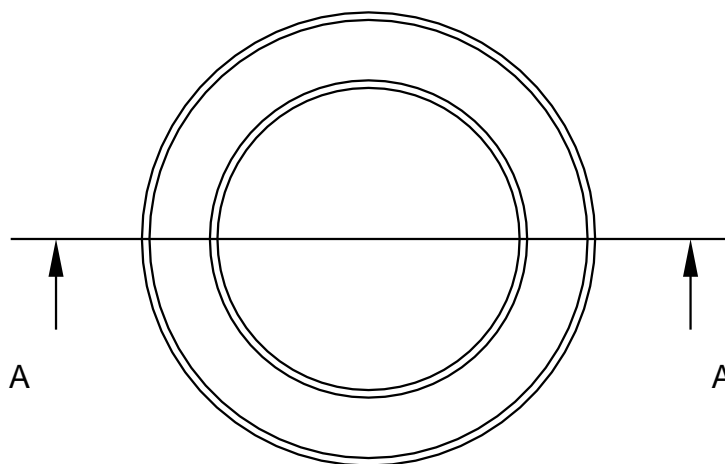

Tolerance

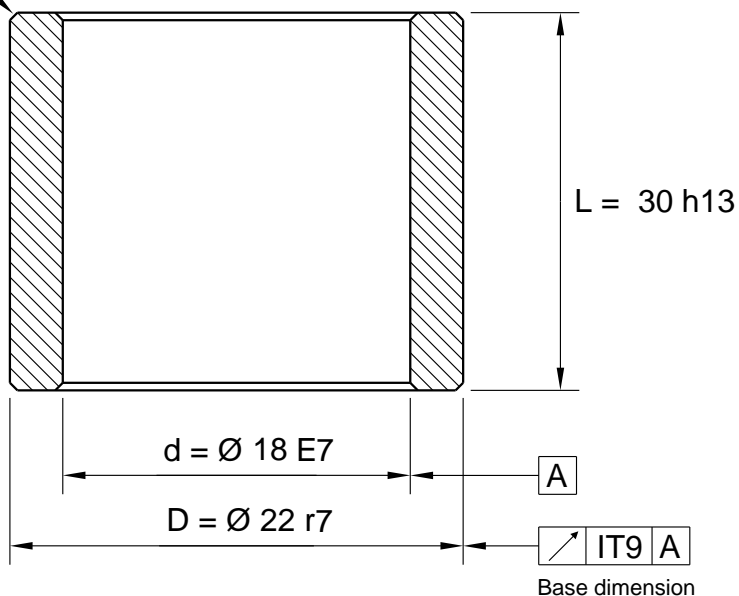

Inside dia < 45,0 E7

Inside dia > 45,0 E8

Outside dia < 51,0 r7

Outside dia > 51,0 r8

All dimensions in mm

	 IRONCAD 2D drawing 3D model is available	General Tolerances acc to: ISO 2768-mK	File Name: 540-018X22X30_Schema.icd			Template created date 2015-12-17 14:07
			Drawn by: UP	Weight g: 30.37	Material: Sintered Bronze	Drawing created date 2015-12-17
 www.lagermetall.se			Cylindrical bearing SS2991 Sintered bronze Ø 18/22x30			Sheet No: 1 (1) ...
						Doc. No: 540-018x22x30