

Max F = 0,6 x 45° (4x)

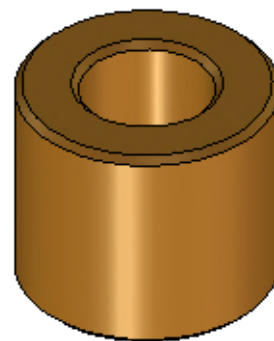
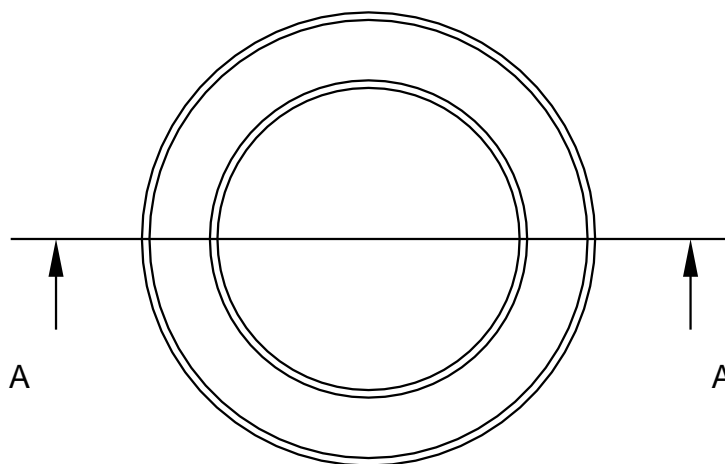
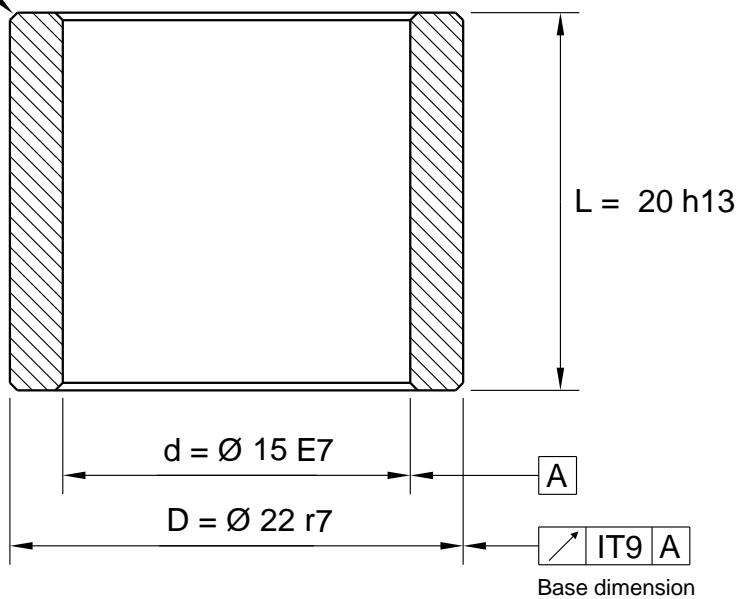

Tolerance

Inside dia < 45,0 E7

Inside dia > 45,0 E8

Outside dia < 51,0 r7

Outside dia > 51,0 r8

All dimensions in mm

		General Tolerances acc to: ISO 2768-mK	File Name: 540-015X22X20_Schema.icd			Template created date 2015-12-17 14:07
			Drawn by: UP	Weight g: 32.61	Material: Sintered Bronze	Drawing created date 2015-12-17
 www.lagermetall.se			Cylindrical bearing SS2991 Sintered bronze Ø 15/22x20			Sheet No: 1 (1) ...
						Doc. No: 540-015x22x20