

Max F = 0,6 x 45° (4x)

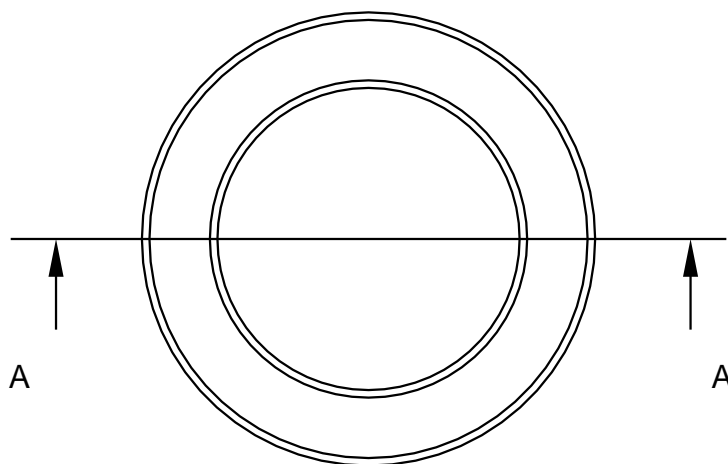
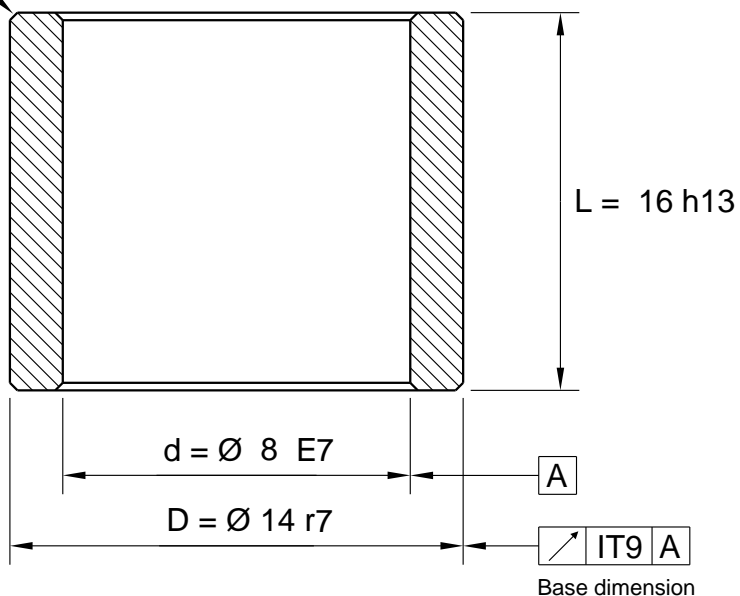

### Tolerance

Inside dia < 45,0 E7

Inside dia > 45,0 E8

Outside dia < 51,0 r7

Outside dia > 51,0 r8

All dimensions in mm

		General Tolerances acc to: <b>ISO 2768-mK</b>	File Name: 540-008X14X16_Schema.icd			Template created date 2015-12-17 14:07
			Drawn by: <b>UP</b>	Weight g: <b>13.23</b>	Material: <b>Sintered Bronze</b>	Drawing created date 2015-12-17
 www.lagermetall.se			Cylindrical bearing SS2991 <b>Sintered bronze Ø 8/14x16</b>			Sheet No: <b>1 ( 1 ) ...</b>
						Doc. No: 540-008x14x16